

# КОНТРОЛЕР / ЧЕТЕЦ

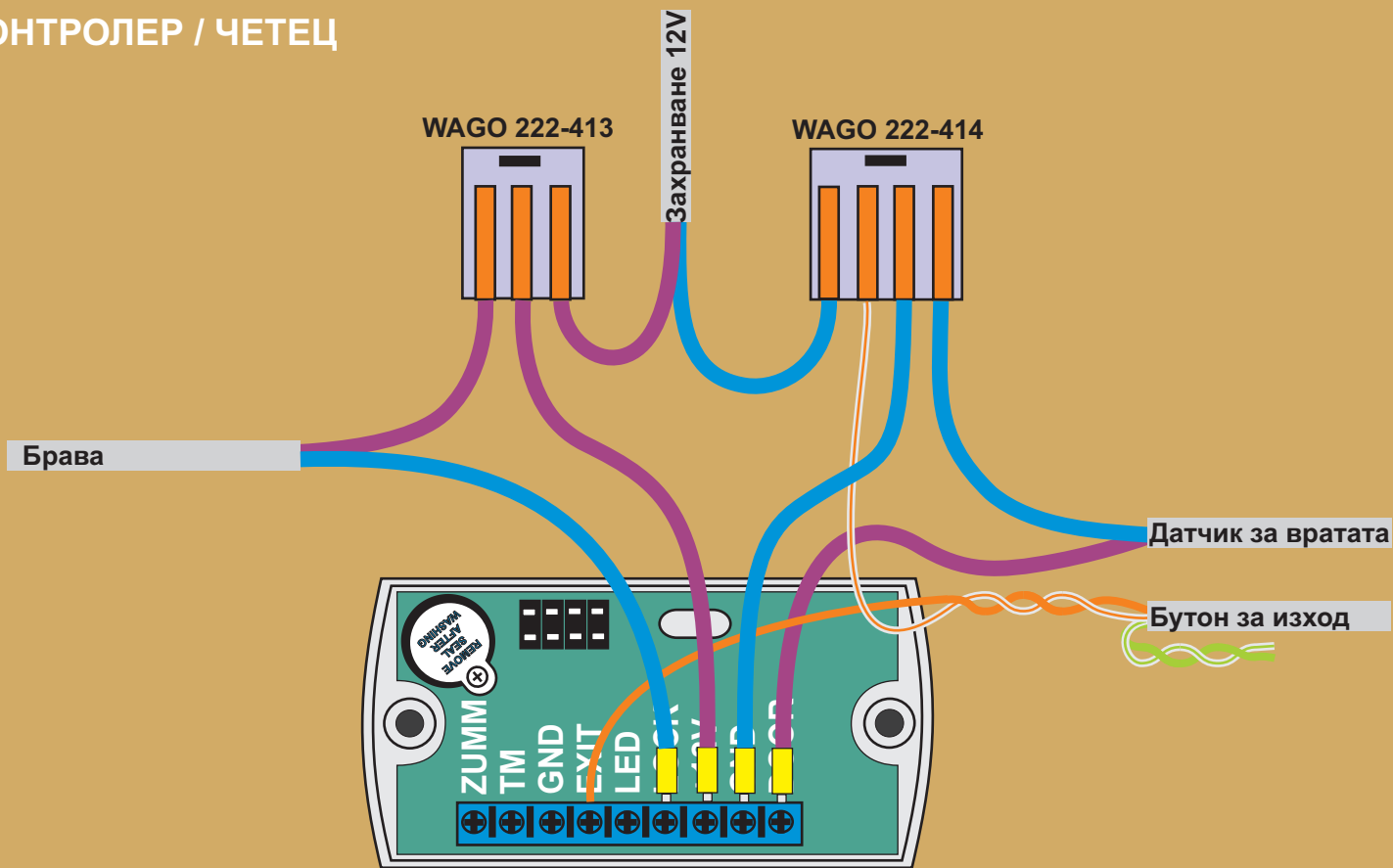

# КАБЕЛИ

H03VVH2-F 2\*2,5/2\*0,7

UDP 24 AWG 5E 2 Pairs

# БУТОН ЗА ИЗХОД

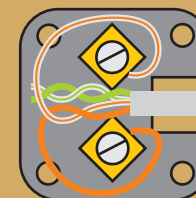
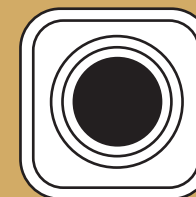

Бутон за изход

# ЕЛЕКТРОМАГНИТНА БРАВА

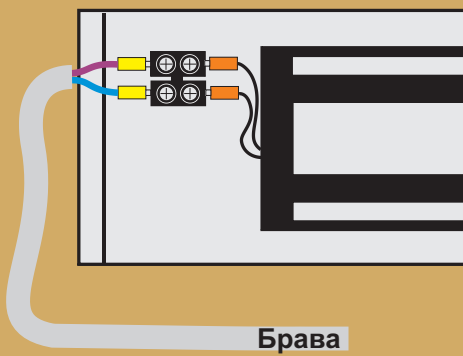

# ДАТЧИК ЗА ВРАТАТА



# ЗАХРАНВАНЕ

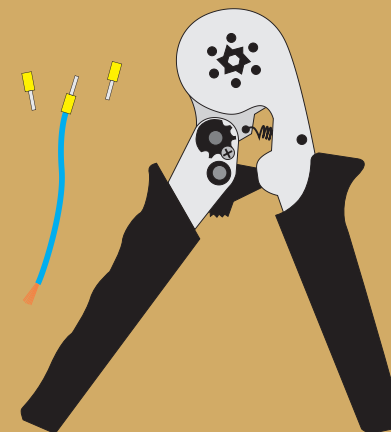
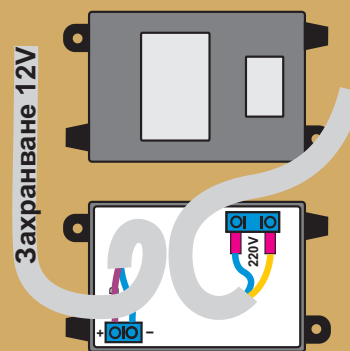

ЕЛЕКТРОМАГНИТНА БРАВА

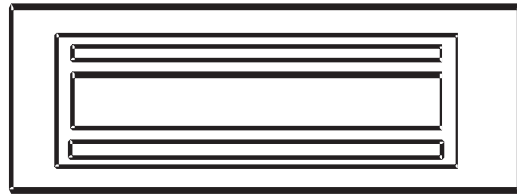

КОНТРОЛЕР / ЧЕТЕЦ



+12  
ЗАХРАНВАНЕ  
ЗЕМЯ

ДАТЧИК ЗА ВРАТАТА



БУТОН ЗА ИЗХОД

