

КОНТРОЛЕР

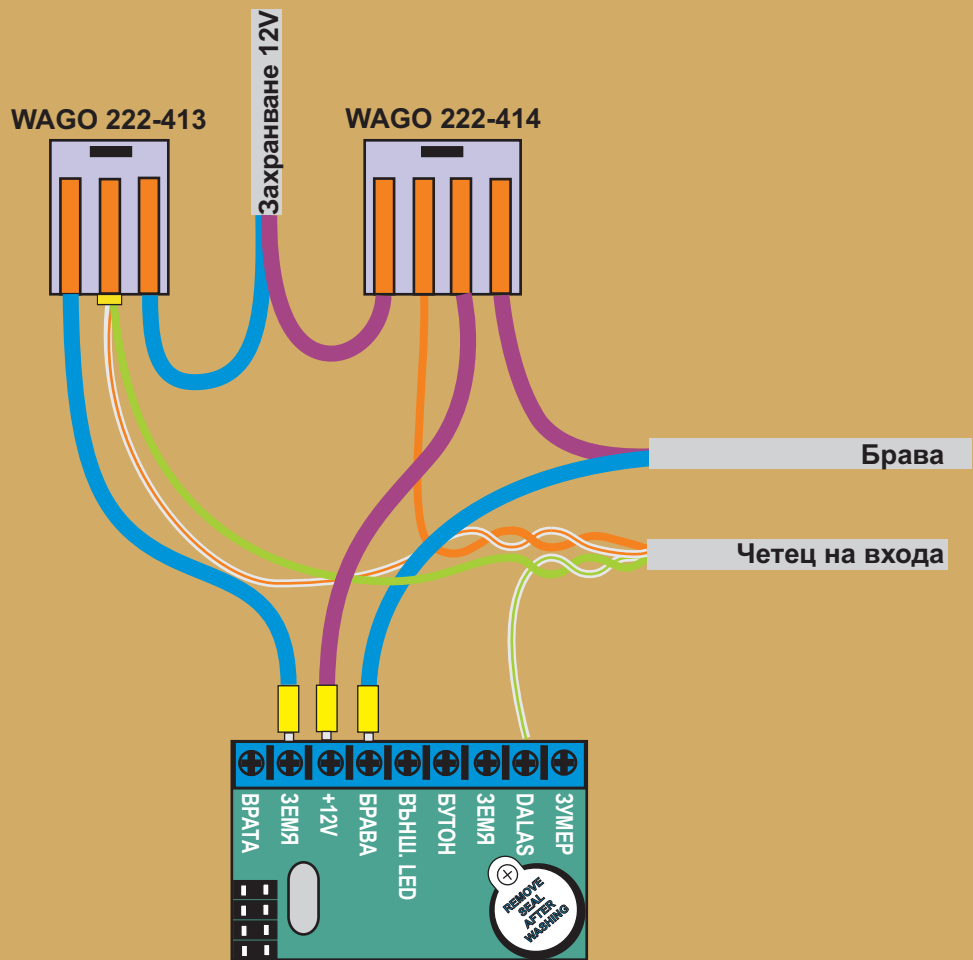

КАБЕЛИ

H03VVH2-F 2*2,5/2*0,7

UDP 24 AWG 5E 2 Pairs

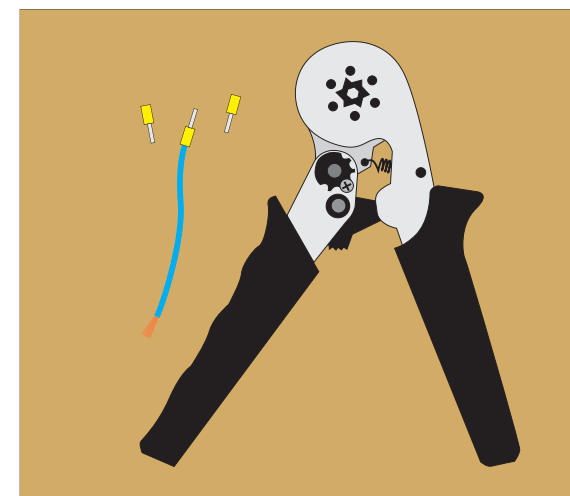

ЕЛЕКТРОМЕХАНИЧНА БРАВА

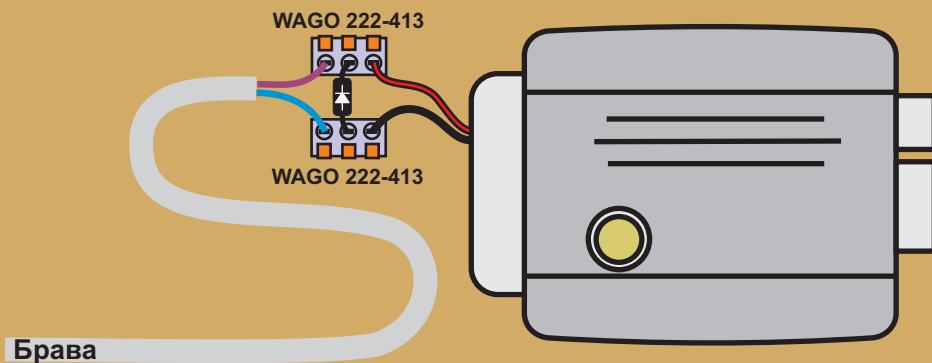

ЗАХРАНВАНЕ

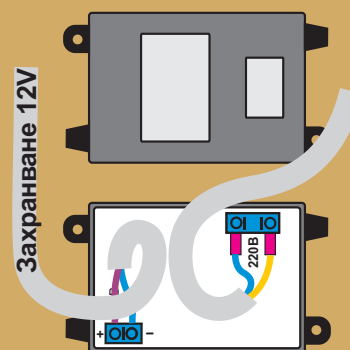

ЧЕТЕЦ

Вход

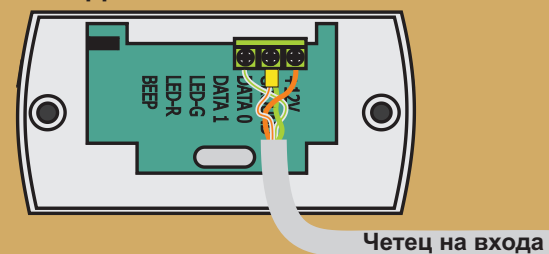

ЕЛЕКТРОМЕХАНИЧНА БРАВА

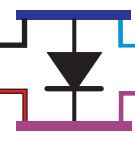
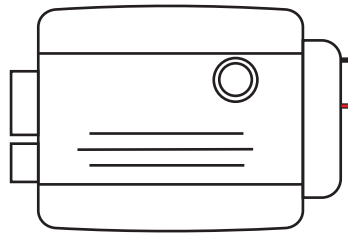

КОНТРОЛЕР

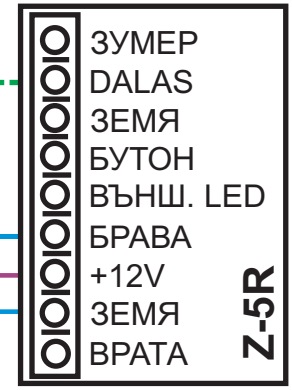

+12
ЗАХРАНВАНЕ
ЗЕМЯ

ЧЕТЕЦ НА ВХОДА

