

# КОНТРОЛЕР / ЧЕТЕЦ

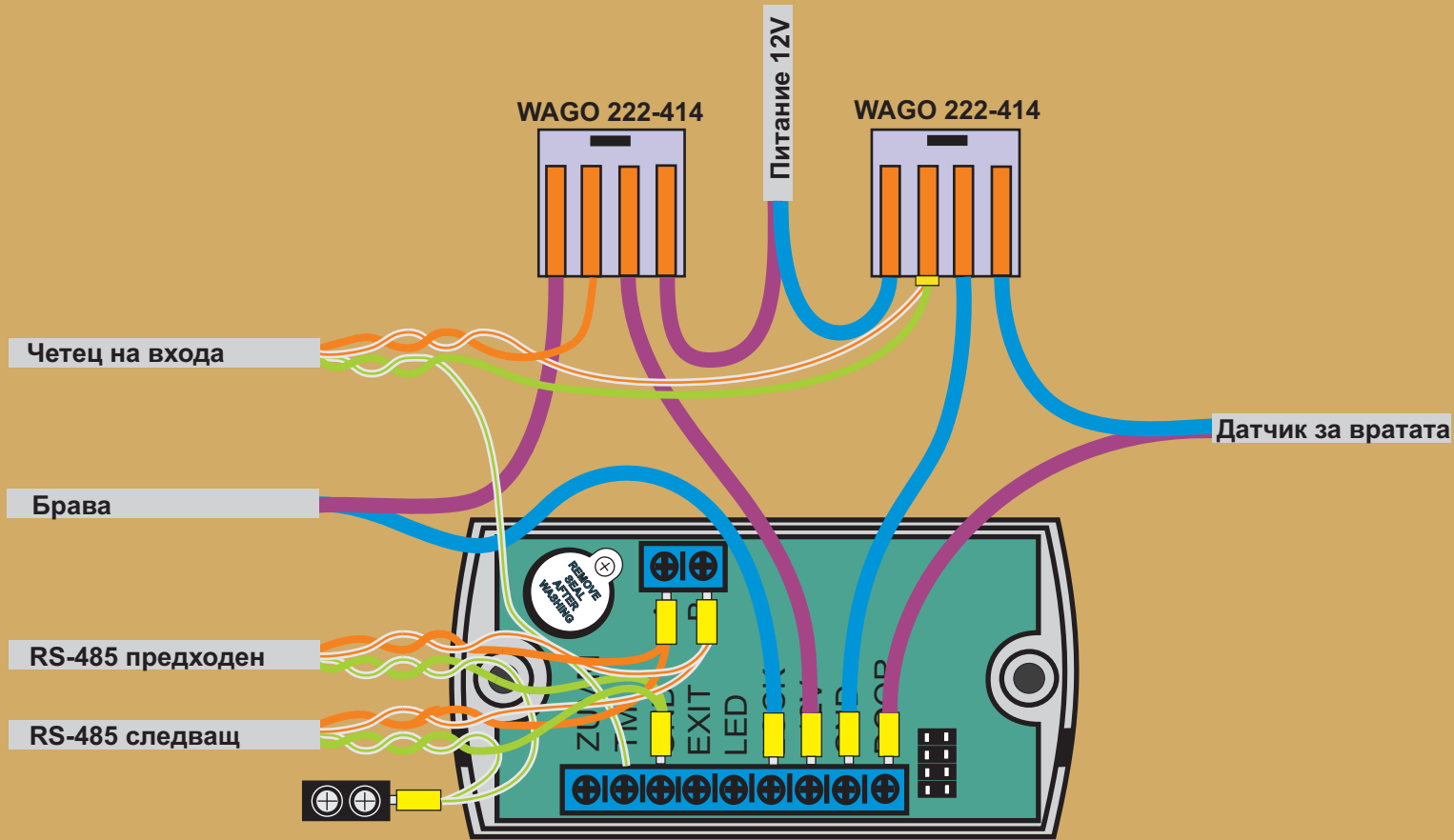

# КАБЕЛИ

H03VVH2-F 2\*2,5/2\*0,7

UDP 24 AWG 5E 2 Pairs

# МРЕЖА RS485

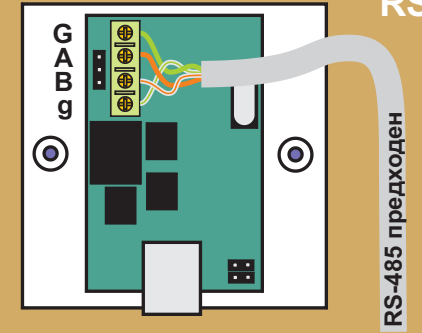

# Четец

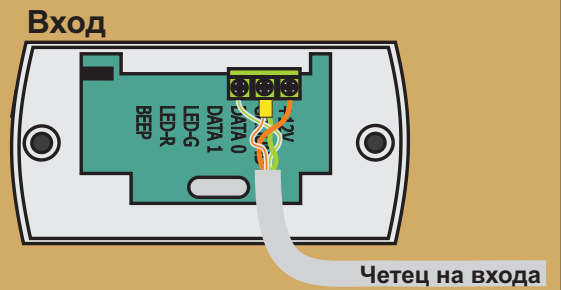

# ЕЛЕКТРОМАГНИТНА БРАВА

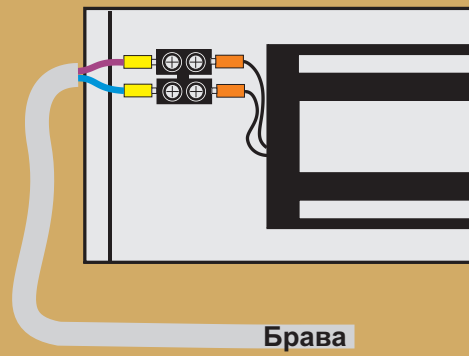

# ДАТЧИК ЗА ВРАТАТА

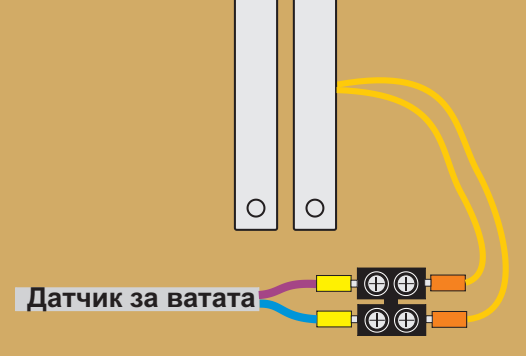

# ЗАХРАНВАНЕ

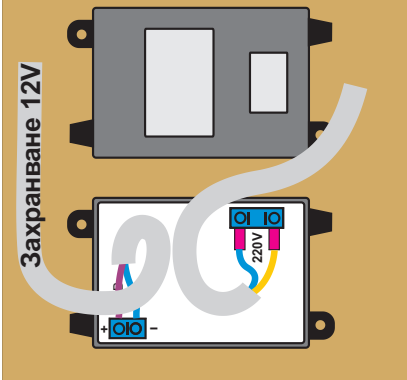

МРЕЖА RS485

G g A B

ЕЛЕКТРОМАГНИТНА БРАВА

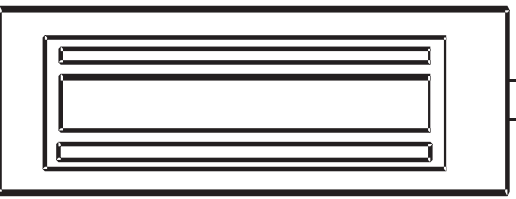

КОНТРОЛЕР / ЧЕТЕЦ



+12

ЗАХРАНВАНЕ

ЗЕМЯ

ЧЕТЕЦ НА ВХОДА



ДАТЧИК ЗА ВРАТАТА

